



Supplier of access control products

## Touchless Exit Button Introduction

### Model: K1-1 / K1

NO Touch Style Exit Button;  
 NO/NC/COM;  
 Stainless Steel Face Plate;  
 Sensitive Distance 5~15cm;  
 Remote Control Function Optional;



### ► Features

- Wide Voltage DC 12~24V;
- Sensitive Distance 5~15cm;
- NO/NC/COM;
- Standby Blue LED, Active Green LED
- Laser texture, Not discolor



View	Front (Standby)	Front (Response)	Side	Back
Photos				

### ► Product Parameter



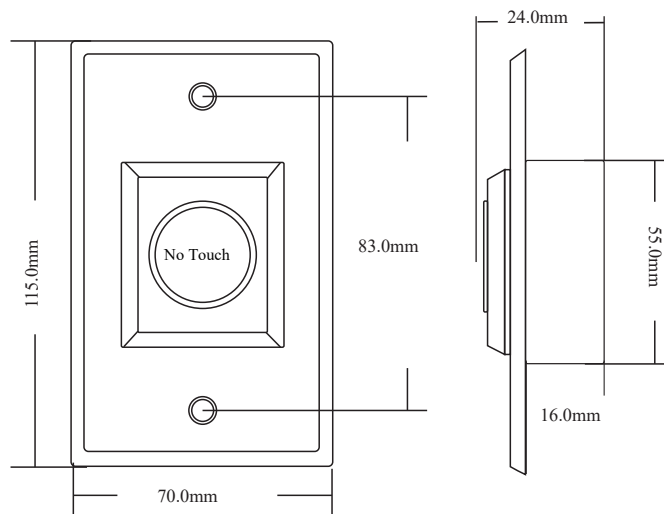

Dimensions	115L*70W*16H(mm)
Power Supply	DC12-24V
Output Contact	NO/NC/COM
Sensitive Distance	5-15cm (Adjustable)
LED Indicator	Standby blue, Response green
Material	Stainless steel
Panel logo	Customizable
Mechanical Life	500,000 Tested aging test qualified
Door Type	Hollow door frame installation
Accessories	115*70mm Back box optional
Operating Temp	-20°C~+55°C(-4-131F)
Operating humidity	0-95%(RH)
Product Weight	0.13KG
Package Quantity	1 PCS/box, 100 PCS/case

### ► Dimensions





CE RoHS

► Support customization of the following patterns.

Infrared induction switch					
Model	K1	K1-1-F	K1-1-R	K1-1-S	K1-1-P
Pattern	Hand Symbol (English)	French	Russian	Spanish	Portuguese
Photos					

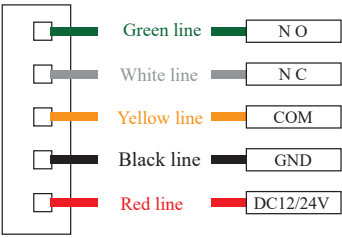
Optional Back box			
Model	M70	M70-1	PG70
Material	Zinc alloy (Mirror)	Zinc alloy (Matt)	ABS
Size(mm)	115L*70W*28H	115L*70W*28H	115L*70W*30.5H
Photos			

Switch operation instructions	
<p>Wiring instructions</p> 	<p>Adjustable range</p>  <p>D Potentiometers</p> <p>☞ Turn left near (Counterclockwise)</p> <p>☜ Turn right far (Clockwise)</p>