

Call Point

Model: 809G/809GD



Emergency Call Point;
 SPDT (809G), NO/NC/COM;
 DPDT(809GD), 2NO/2NC/2COM;
 ABS Material.





► Features:

- Emergency Call Point;
- SPDT (809G), NO/NC/COM;
- DPDT(809GD), 2NO/2NC/2COM;
- ABS Material.



View	Front	Side	Back
Photos			

► Optional Accessory

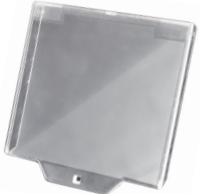
Model	GLASS-C	GLASS-CA	GLASS-E	809COVER
Title	Glass sheet - 1	Glass sheet - 2	Glass sheet - English	Protecting cover
Photos				

▶ Product Parameter

Model	809G	809GD
Output Contact	NO/NC/COM	2NO/2NC/2COM
Power Supply	DC12-24V, 2A	
Size(mm)	86L*86W*52H	
Material	ABS	
Weight(KG)	0.165	

Panel logo	Customizable
Mechanical Life	500,000 Tested aging test qualified
Operating Temp	-20°C~+55°C(-4-131F)
Operating humidity	0-95% (RH)
Package Quantity	1 PCS/box, 100 PCS/ctn.

▶ Dimensions

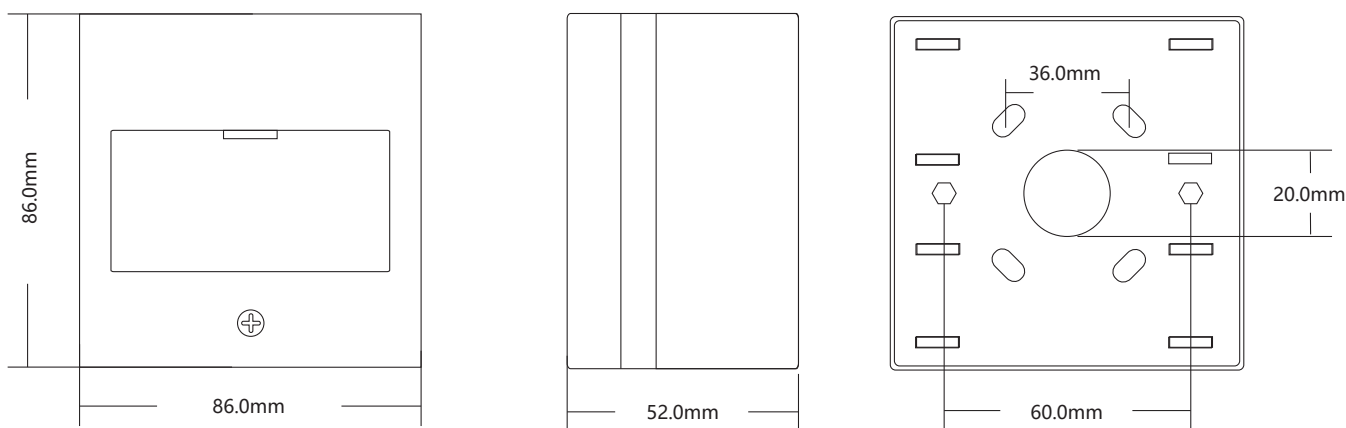

▶ Customized plate is available.

Model	809G/809GD		
Pattern	Panel - Custom Pattern	Panel - Custom LOGO	Glass Sheet - Custom Pattern
Photos	