



RG-AP680(CD)

Wi-Fi 6 Dual-Radio Access Point

01

Product Overview

Ruijie RG-AP680(CD) is a high-performance Wi-Fi 6 (802.11ax) enterprise outdoor AP with IP68 rating, which can endure extreme outdoor conditions.

The RG-AP680(CD) provides concurrent dual-radio design with up to 2.402 Gbps data rate, and offers 4 spatial streams (4SS) and built-in directional antenna. The RG-AP680(CD) supports switching between Fat and Fit modes, offers one SFP port and one 10/100/1000M port with PoE or local power supply. Its design considers wireless network security, RF control, mobile access, QoS, seamless roaming, and other factors. Teaming up with Ruijie RG-WS wireless access controller and Ruijie Cloud, it offers wireless client data forwarding and security and access control with ease.

The RG-AP680(CD) adopts the IP68 rating design for the enclosure, which is suitable for extreme indoor and outdoor environments. It can withstand extreme weather and other environmental conditions, thereby greatly facilitating installation and maintenance. Equipped with the built-in directional antenna, the RG-AP680(CD) can achieve Wi-Fi coverage in diverse scenarios.

Upon uprising challenges of management efficiency and wireless security, the RG-AP680(CD) supports

hybrid management. Either deployed as standalone AP (Fat mode) or managed AP (Fit mode), the RG-AP680(CD) can detect the operation mode automatically without firmware upgrade. To ensure security, enterprise customers can choose one of the following management modes depending on the functionality and capacity:

- Public cloud: Ruijie Cloud is targeted for the SME segment with integrated captive portal, identity authentication, and reporting features. Together with Ruijie Cloud App (free download), SME customers can provision and manage their networks at fingertips.
- Hybrid cloud: The AP680(CD) can be used with the RG-WS6000 series wireless access controller and Ruijie Cloud (optional) for high-density scenarios such as enterprise offices or campuses with one or more sites. The wireless access controller provides integrated wireless management and authentication, and is installed at the customer's site. Each cluster allows a maximum of 5,000 APs. Optionally, the cloud management platform allows for value-added functions such as centralized device configuration and monitoring, and reporting.

02

Product Appearance



Front View



Left Top View



Rear View

03

Product Highlights

- Wi-Fi 6 certification
- Data rate of up to 2.402 Gbps and concurrent dual-radio design
- Built-in smart directional antenna
- Excellent environmental adaptability: IP68, -40°C to +65°C (-40°F to +149°F), and 9 kV surge protection
- OFDMA, MU-MIMO technologies for minimal wireless signal interference
- Hybrid management: support for thousands of standalone APs, and AC-managed, and public cloud deployment options
- Mobile management: free mobile applications for Ruijie Cloud customers

04

Product Features

Multiple Service Ports

The RG-AP680(CD) provides the wired access rate of up to 2 Gbps.

Both the auto-negotiation Ethernet electrical port and optical port provide a maximum data rate of 1 Gbps, guaranteeing high-speed transmission of service data between wireless and wired networks.



High-speed Wireless Access for Better Experience

The RG-AP680(CD) optimizes user experience by maximizing Wi-Fi utilization and substantially reducing airtime competition between clients. It provides Orthogonal Frequency-Division Multiple Access (OFDMA) and Multi-User Multiple-Input Multiple-Output (MU-MIMO). With dual-5 GHz radios, 2 spatial streams (2SS), and 80 MHz channel bandwidth (HE80), the RG-AP680(CD) delivers the data rate of up to 2.402 Gbps at 5 GHz band, providing pioneering wireless capabilities for enterprises.

1024-QAM High-speed Access

The RG-AP680(CD) adopts the dual-radio design and complies with Wi-Fi standard IEEE 802.11ax. When

dual radios work at 5 GHz, it can provide a wireless data rate of up to 2.402 Gbps. When working at 2.4 GHz and 5 GHz, it can provide a wireless data rate of up to 1.775 Gbps. It achieves high-speed wireless experience in the preceding two modes.

OFDMA High-density User Access

OFDMA in 802.11ax enables the RG-AP680(CD) to divide a WLAN channel into multiple narrower sub-channels, with each user occupying one or more sub-channels. The RG-AP680(CD) can schedule services of multiple users, and receive and send packets concurrently. This reduces contention for air interface resources and backoff, shortens the network latency, and improves the network efficiency.

MU-MIMO

The RG-AP680(CD) maximizes the use of MU-MIMO, which can effectively improve the throughput of a wireless network by exchanging data with multiple single-stream or dual-stream client devices simultaneously.

Seamless Switching

The RG-AP680(CD) supports Hotspot 2.0 of Wi-Fi Association (WFA) and automatic identity recognition, providing clients with seamless cellular-to-Wi-Fi switching.

Diverse Wi-Fi Technologies

It supports RF transmission technologies:

- Dynamic frequency selection (DFS) optimizes the use of available RF spectrum to prevent radar channel interference.
- Cyclic delay/shift diversity (CDD/CSD) improves downlink RF performance, and converts spatial diversity to frequency diversity to avoid intersymbol interference, thus reducing bit error rate (BER) and effectively reducing signal distortion.
- Maximum ratio combining (MRC) improves the signal quality at the receiving end and enhances reliability and performance of received signals.

It supports RF channel coding technologies:

- Space-time block coding (STBC) increases the range and improves signal receiving, and enhances reliability of data transmission.
- Low-density parity check (LDPC) corrects errors efficiently and improves the throughput.
- Transmit beam-forming (TxBF) expands the signal coverage and enhances the reliability of specific devices, thereby improving the data rate.

Intelligent Optimization, Reliability Guarantee

Intelligent Recognition, One-Click Network Optimization

The RG-AP680(CD) can intelligently identify mobile clients such as iOS and Android clients and PCs. It can be used to implement visualized wireless network management based on the wireless client type and optimize a network in one-click mode.

The RG-AP680(CD) embeds client experience measurement and environment collection capability. It can be used with the RG-WS wireless access controller for intelligent analysis and automatic RF resource scheduling. It can adjust the RF power and intelligently allocate channels to solve problems such as co-channel interference, adjacent channel interference, and roaming stickiness.

Flexible WDS Networking Modes

The RG-AP680(CD) supports the wireless distribution system (WDS) and can provide wireless network coverage or a wireless bridge. It can provide high-performance wireless bridging with a distance of 3 km (1.86 miles). Therefore, it is suitable for wide outdoor wireless network coverage and high-speed wireless network in a long distance, facilitating

outdoor wireless network deployment.

Intelligent Local Forwarding

The RG-AP680(CD) integrates intelligent local forwarding technology to eliminate the traffic bottleneck on its connected wireless access controller. The data forwarding mode of the RG-AP680(CD) can be flexibly pre-configured through Ruijie's wireless access controller. Then the RG-AP680(CD) determines whether data needs to be forwarded by the wireless access controller or be sent to a wired network for data exchange based on the SSID or user VLAN.

With the local forwarding technology, the RG-AP680(CD) classifies the data that is sensitive to the delay and requires real-time high-performance transmission, and forwards it through a wired network. This greatly relieves the traffic burden of the wireless access controller and better adapts to heavy-traffic transmission on 802.11ax networks.

Client Access Optimization

The RG-AP680(CD) can dynamically measure parameters such as the uplink Received Signal Strength Indicator (RSSI), noise floor, and channel utilization to intelligently identify the client network status. Moreover, it can steer clients to preferentially connect to 5 GHz or APs with better experience. This solves the problems of roaming stickiness, remote association, and load imbalance, and improves user experience.

Advanced Network Coexistence

The RG-AP680(CD) supports advanced network coexistence. It uses the built-in filter to automatically minimize the impact of interference from non-Wi-Fi network devices.

Abundant QoS Policies

The RG-AP680(CD) provides abundant QoS policies. It supports bandwidth limiting based on the WLAN, AP, and STA, and provides Wi-Fi Multimedia (WMM) that defines priorities for different service data. Therefore, it implements immediate and quantitative transmission of audio and video data, and guarantees smooth application of multimedia services.

The multicast-to-unicast technology supported by the RG-AP680(CD) solves the video freezing problem caused by packet loss or long latency in Video on Demand (VoD) and other multicast applications on a wireless network. It enhances the experience in the use of multicast video services on a wireless network.

Green Design and Low Power Consumption

The RG-AP680(CD) incorporates packet-based power control technology. With high-performance power design, the RG-AP680(CD) is energy-efficient while providing high-speed wireless access services.

Rich IoT Platform Features

The RG-AP680(CD) integrates Bluetooth 5.0 and 802.15.4 RF (ZigBee support) to simplify deployment and management of IoT-based location services, asset tracking services, security solutions, and IoT sensors. It allows access through Bluetooth serial ports.

Easy Installation and Deployment

An adjustable mount-kit is available by default for painless deployment optimization. The AP is easily adjustable (maximum: 60°) to adapt to various scenarios.

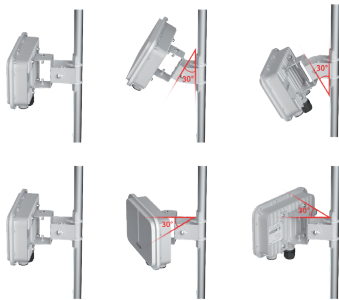

Adjustable Mount-kit of RG-AP680 Series

Comprehensive Security Protection and Ease of Use

Multiple Easy-to-Use Authentication Modes

The RG-AP680(CD) supports various authentication and encryption technologies, including web, 802.1X, WEP (64/128 bits), WPA, WPA2, WPA3, voucher code, user accounts, SMS, and PSK. WPA3 includes WPA3-Personal, WPA3-Enterprise, and WPA3-OWE. In compliance with standard Network Access Control (NAC), the AC offers control policies through

authentication, authorization, device compliance check, and network attack detection or prevention. All these features guarantee high network security for authenticated users.

Flexible Device Management Modes

Flexible Switching Between Fat, Fit, and Cloud Modes

The RG-AP680(CD) supports flexible switchover among Fat, Fit, and cloud deployment modes. When the RG-AP680(CD) is deployed in Fat and cloud mode, it can operate as a single device and be managed by the local access controller (AC). It can also be connected to the Ruijie public cloud for cloud-based management. When the RG-AP680(CD) is deployed in Fit mode, it can be used with the AC to achieve more functions. In Fit mode, the RG-AP680(CD) can be deployed through Zero Touch Provisioning (ZTP). In addition, complete remote management also greatly enhances the O&M management efficiency of a wireless network.

Bluetooth Serial Port for Easy Maintenance

The RG-AP680(CD) supports switching between Bluetooth serial port and iBeacon. If the Bluetooth serial port is used by default, a network administrator can manage the device through the mobile phone upon device faults, without onsite device maintenance.

Mobile Monitoring and Optimization

You can use the free Ruijie Cloud App to achieve simple network management experience. This app features unified device lifecycle management, switches, and security gateways. The app also simplifies device configuration, monitoring, and optimization. For details, visit official website at <https://www.ruijie.com/en-global/products/smb/cloud-service/cloud-service/ruijie-cloud-solution>



All-in-One for Small Branch Office

In small branch office scenarios, the RG-AP680(CD) provides wireless access services for office areas. This simplifies network deployment and saves building costs.

PPPoE

The RG-AP680(CD) can function as a PPPoE client and

connects to the Internet through PPPoE. In this case, no gateway needs to be deployed in a branch office area for Internet access.

NAT

The RG-AP680(CD) supports the Network Address Translation (NAT) function to translate addresses between the LAN in the branch office and the Internet.

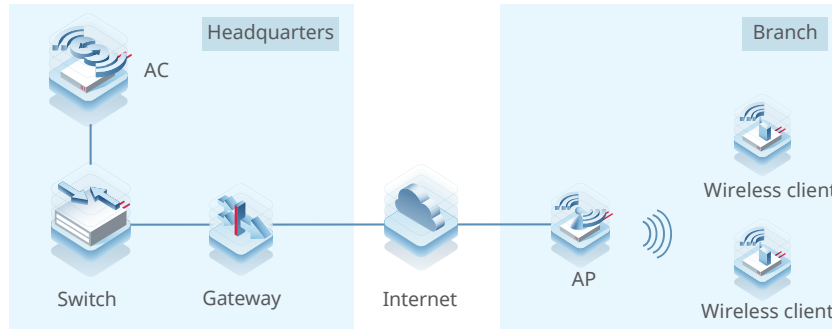

05 Specifications

Hardware Specifications

Dimensions and Weight

Dimensions and Weight	RG-AP680(CD)
Unit dimensions (W x D x H)	251 mm x 168 mm x 64 mm (9.88 in. x 6.61 in. x 2.52 in.)
Shipping dimensions (W x D x H)	451 mm x 242 mm x 337 mm (17.76 in. x 9.53 in. x 13.27 in.)
Unit weight	Main unit: 1.17 kg (2.58 lbs) Mounting bracket: 0.2 kg (0.44 lbs)
Shipment weight	5.84 kg (12.87 lbs)
Mounting	Wall/Pole-mount (a mounting bracket is delivered with the main unit)

Wi-Fi Radio

Wi-Fi Radio	RG-AP680(CD)
Radio design	Dual-radio and up to four spatial streams: <ul style="list-style-type: none"> Radio 1: 2.4 GHz/5 GHz, two spatial streams, 2x2 MU-MIMO Radio 2: 5 GHz, two spatial streams, 2x2 MU-MIMO
Operating frequencies	Radio 1: 802.11b/g/n/ax <ul style="list-style-type: none"> 2.400 GHz to 2.4835 GHz, channels 1 to 13 Radio 2: 802.11a/n/ac/ax <ul style="list-style-type: none"> 5.150 GHz to 5.250 GHz, U-NII-1, channels 36, 40, 44, and 48 5.250 GHz to 5.350 GHz, U-NII-2A, channels 52, 56, 60, and 64 5.470 GHz to 5.725 GHz, U-NII-2C, channels 100, 104, 108, 112, 116, 120, 124, 128, 132, 136, and 140 5.725 GHz to 5.850 GHz, U-NII-3/ISM, channels 149, 153, 157, 161, and 165 Note: Available frequency bands may vary with countries or regions. To use the above-mentioned frequency bands, ensure that they are supported in your country or region. For details, see WLAN Country or Region Codes and Channel Compliance .

Wi-Fi Radio	RG-AP680(CD)
Data rates	Combined peak data rate for 2.4 GHz and 5 GHz radios: 1.775 Gbps Combined peak data rate for 5 GHz and 5 GHz radios: 2.402 Gbps Radio 1: 2.4 GHz: 574 Mbps <ul style="list-style-type: none"> • Two spatial stream Single User (SU) MIMO for up to 574 Mbps wireless data rate to individual 2SS HE40 802.11ax client devices (maximum) • Two spatial stream Single User (SU) MIMO for up to 287 Mbps wireless data rate to individual 2SS HE20 802.11ax client devices (typical) 5 GHz: 1.201 Gbps <ul style="list-style-type: none"> • Two spatial stream Single User (SU) MIMO for up to 1.201 Gbps wireless data rate to individual 2SS HE80 802.11ax client devices (maximum) • Two spatial stream Single User (SU) MIMO for up to 574 Mbps wireless data rate to individual 2SS HE40 802.11ax client devices (typical) • Two spatial stream Multi-User (MU) MIMO for up to 1.201 Gbps wireless data rate to up to two 1SS HE80 802.11ax DL-MU-MIMO capable client devices simultaneously (maximum) • Two spatial stream Multi-User (MU) MIMO for up to 574 Mbps wireless data rate to up to two 1SS HE40 802.11ax DL-MU-MIMO capable client devices simultaneously (typical) Radio 2: 5 GHz, 1.201 Gbps <ul style="list-style-type: none"> • Two spatial stream Single User (SU) MIMO for up to 1.201 Gbps wireless data rate to individual 2SS HE80 802.11ax client devices (maximum) • Two spatial stream Single User (SU) MIMO for up to 574 Mbps wireless data rate to individual 2SS HE40 802.11ax client devices (typical) • Two spatial stream Multi-User (MU) MIMO for up to 1.201 Gbps wireless data rate to up to two 1SS HE80 802.11ax DL-MU-MIMO capable client devices simultaneously (maximum) • Two spatial stream Multi-User (MU) MIMO for up to 574 Mbps wireless data rate to up to two 1SS HE40 802.11ax DL-MU-MIMO capable client devices simultaneously (typical)
Data rate set	The following 802.11-compliant data rates in Mbps are supported: 2.4 GHz radio <ul style="list-style-type: none"> • 802.11b: 1, 2, 5.5, 11 • 802.11g: 1, 2, 5.5, 6, 9, 11, 12, 18, 24, 36, 48, 54 • 802.11n: 6.5 to 300 (MCS0 to MCS15, HT20 to HT40) • 802.11ac: 6.5 to 400 (MCS0 to MCS9, NSS = 1 to 2, VHT20 to VHT40) • 802.11ax: 8.6 to 574 (MCS0 to MCS11, NSS = 1 to 2, HE20 to HE40) 5 GHz radio <ul style="list-style-type: none"> • 802.11a: 6, 9, 12, 18, 24, 36, 48, 54 • 802.11n: 6.5 to 300 (MCS0 to MCS15, HT20 to HT40) • 802.11ac: 6.5 to 867 (MCS0 to MCS9, NSS = 1 to 2, VHT20 to VHT80) • 802.11ax: 8.6 to 1,200 (MCS0 to MCS11, NSS = 1 to 2, HE20 to HE80)
Packet aggregation	802.11n/ac/ax: A-MPDU and A-MSDU
Antenna type	Built-in intelligent antennas
Antenna gain	2.4 GHz: 9 dBi 5 GHz: 9 dBi
Maximum transmit power	2.4 GHz radio: 28 dBm (25 dBm per chain) 5 GHz radio: 28 dBm (25 dBm per chain) Note: The transmit power is limited by local regulatory requirements. For details, see WLAN Country or Region Codes and Channel Compliance . Thailand 2.400 GHz to 2.4835 GHz: 20 dBm 5.470 GHz to 5.725 GHz: 30 dBm 5.725 GHz to 5.825 GHz: 30 dBm
Power increment	Configurable in increments of 1 dBm
Radio technologies	802.11b: Direct-Sequence Spread-Spectrum (DSSS) 802.11a/g/n/ac: Orthogonal Frequency-Division Multiplexing (OFDM) 802.11ax: Orthogonal Frequency Division Multiple Access (OFDMA)
Modulation types	802.11b: BPSK, QPSK, CCK 802.11a/g/n: BPSK, QPSK, 16-QAM, 64-QAM, 256-QAM 802.11ac: BPSK, QPSK, 16-QAM, 64-QAM, 256-QAM 802.11ax: BPSK, QPSK, 16-QAM, 64-QAM, 256-QAM, 1024-QAM

The following table lists the radio frequency performance of Wi-Fi including different frequency bands, protocols, and data rates. It is country-specific, and Ruijie Networks reserves the right of interpretation.

Wi-Fi Radio	RG-AP680(CD)		
Frequency Band and Protocol	Data Rate	Maximum Transmit Power per Transmit Chain	Maximum Receive Sensitivity per Receive Chain
2.4 GHz 802.11b	1 Mbps	25 dBm	-92 dBm
	2 Mbps	25 dBm	-82 dBm
	5.5 Mbps	25 dBm	-84 dBm
	11 Mbps	25 dBm	-78 dBm
2.4 GHz 802.11g	6 Mbps	25 dBm	-84 dBm
	24 Mbps	23 dBm	-74 dBm
	36 Mbps	23 dBm	-72 dBm
	54 Mbps	20 dBm	-67 dBm
2.4 GHz 802.11n (HT20)	MCS0	25 dBm	-84 dBm
	MCS7	20 dBm	-66 dBm
2.4 GHz 802.11n (HT40)	MCS0	25 dBm	-79 dBm
	MCS7	20 dBm	-63 dBm
2.4 GHz 802.11ax (HE20)	MCS0	25 dBm	-84 dBm
	MCS11	18 dBm	-54 dBm
2.4 GHz 802.11ax (HE40)	MCS0	25 dBm	-80 dBm
	MCS11	18 dBm	-51 dBm
5 GHz 802.11a	6 Mbps	25 dBm	-84 dBm
	24 Mbps	23 dBm	-74 dBm
	36 Mbps	23 dBm	-72 dBm
	54 Mbps	20 dBm	-67 dBm
5 GHz 802.11n (HT20)	MCS0	25 dBm	-84 dBm
	MCS7	20 dBm	-66 dBm
5 GHz 802.11n (HT40)	MCS0	25 dBm	-81 dBm
	MCS7	20 dBm	-63 dBm
5 GHz 802.11ac (VHT20)	MCS0	25 dBm	-84 dBm
	MCS9	19 dBm	-61 dBm
5 GHz 802.11ac (VHT40)	MCS0	25 dBm	-81 dBm
	MCS9	19 dBm	-56 dBm
5 GHz 802.11ac (VHT80)	MCS0	25 dBm	-78 dBm
	MCS9	19 dBm	-53 dBm
5 GHz 802.11ax (HE20)	MCS0	25 dBm	-84 dBm
	MCS11	18 dBm	-54 dBm
5 GHz 802.11ax (HE40)	MCS0	25 dBm	-81 dBm
	MCS11	18 dBm	-51 dBm
5 GHz 802.11ax (HE80)	MCS0	25 dBm	-78 dBm
	MCS11	18 dBm	-48 dBm

Bluetooth Radio

Bluetooth Radio	RG-AP680(CD)
Bluetooth	Bluetooth 5.0
Antenna type	Integrated omnidirectional antenna
Maximum antenna gain	4.5 dBi
Maximum transmit power	10 dBm
Receive sensitivity	-88 dBm (@BLE)

Ports Specifications

Ports Specifications	RG-AP680(CD)
Fixed service port	1 x 10/100/1000BASE-T port, supporting PoE input 1 x 1GE SFP port
Fixed management port	1 x RJ45 console port (serial console port)
Status LED	1 x multi-color system status LED 3 x single-color RSSI LEDs
Button	1 x Reset button <ul style="list-style-type: none"> Press the button for shorter than 2 seconds. Then the device restarts. Press the button for longer than 3 seconds. Then the device restores to factory settings.

Power Supply and Consumption

Power Supply and Consumption	RG-AP680(CD)
Input power supply	The AP supports the following two power supply modes: <ul style="list-style-type: none"> 48 V DC/0.35 A power input over DC connector: The DC connector accepts 2.0 mm/6.3 mm center-positive circular plug. A DC power adapter needs to be purchased independently. PoE input over ETH/PoE: The power source equipment (PSE) complies with IEEE 802.3af/at standard (PoE/PoE+). Note: If both DC power and PoE are available, DC power is preferred.
Overall power consumption	Maximum power consumption: 12.95 W <ul style="list-style-type: none"> DC powered: 12.95 W PoE powered (802.3af): 12.95 W PoE+ powered (802.3at): 12.95 W PoE++ powered (802.3bt): 12.95 W Idle mode: 6.0 W

Environment and Reliability

Environment and Reliability	RG-AP680(CD)
Temperature	Operating temperature: -40°C to +65°C (-40°F to +149°F) Storage temperature: -40°C to +85°C (-40°F to +185°F) Note: At an altitude in the range of 3,000–5,000 m (9,842.52–16,404.20 ft.), every time the altitude increases by 220 m (722 ft.), the maximum temperature decreases by 1°C (1.8°F).
Humidity	Operating humidity: 0% RH to 100% RH (non-condensing) Storage humidity: 0% RH to 100% RH (non-condensing)
IP rating	IP68
Mean Time Between Failure (MTBF)	>250,000 hours

Regulatory Compliance

Regulatory Compliance	RG-AP680(CD)
Security regulations	IEC 62368-1 EN 62368-1 EN 60950-22
EMC regulations	EN 55032 EN 55035 EN IEC 61000-3-2 EN 61000-3-3 EN 301 489-1 EN 301489-3 EN 301489-17
Radio frequency regulations	EN 300 328 EN 301 893 EN 300 440 EN 62311 EN IEC 62311 EN 50665 FCC Part 15

*For more country-specific regulatory information and approvals, contact your local sales agency.

Software Specifications

Applicable Software Version	RG-AP680(CD)
Applicable software version	RGOS11.9(6)W1B1 or later

WLAN

WLAN	RG-AP680(CD)
Recommended maximum number of active devices per AP	120
Maximum number of associated clients	1024 Note The number of associated clients varies according to the environment.
Maximum number of BSSIDs	32 (up to 16 BSSIDs per radio)
STA management	SSID hiding Each SSID can be configured with the authentication mode, encryption mechanism, and VLAN attributes independently. Remote intelligent perception technology (RIPT) Intelligent client identification technology Intelligent load balancing based on the STA quantity or traffic
STA limiting	SSID-based STA limiting Radio-based STA limiting
Bandwidth limiting	STA/SSID/AP-based rate limiting
Wireless roaming	Layer 2 and Layer 3 roaming
Wireless Distribution System (WDS)	Supported

Security

Security	RG-AP680(CD)
Authentication and encryption	Remote Authentication Dial-In User Service (RADIUS) PSK, web, 802.1X, WPA, WPA2, and WPA3 authentication SMS authentication (used with the RG-WS series wireless access controller) MAB authentication (used with the RG-WS series wireless access controller) WEP (64/128 bits), WPA-Personal, WPA-Enterprise, WPA2/WPA3(AES), WPA2-Personal, WPA2-Enterprise, WPA3-Personal (WPA2/WPA3 transition mode), WPA3-Enterprise (CCMP), WPA3-OWE
Data frame filtering	Allowlist, static blocklist, and dynamic blocklist
ACL	Dynamic ACL assignment
CPP	Supported
NFPP	Supported

Routing and Switching

Routing and Switching	RG-AP680(CD)
IP service	Static IPv4 address IPv4 DHCP client NAT FTP ALG and NAT DNS ALG
Multicast	Multicast-to-unicast conversion
IPv6 basics	IPv6 addressing, Neighbor Discovery (ND), ICMPv6, IPv6 ping IPv6 DHCP client
IP routing	IPv4/IPv6 static routing
Dial-up Internet connection	PPPoE client

Management

Management	RG-AP680(CD)
Network management	Fault inspection and alarm Information statistics and logging SNMPv1/v2c/v3 NTP Server and NTP Client
Network management platform	Ruijie Cloud Web-based management (Eweb)
User access management	Console, Telnet, SSH, SNMP and TFTP-based management
Fat/Fit/Cloud mode switchover	When the AP works in Fit mode, it can be switched to Fat mode through an AC. When the AP works in Fat mode, it can be switched to Fit mode through the console port or Telnet. When the AP works in Cloud mode, it can be managed through Ruijie Cloud.

06

Antenna Pattern Plots

Horizontal Planes (Top View)

The following figures show the azimuth antenna pattern at 2.4 GHz and 5 GHz radios.

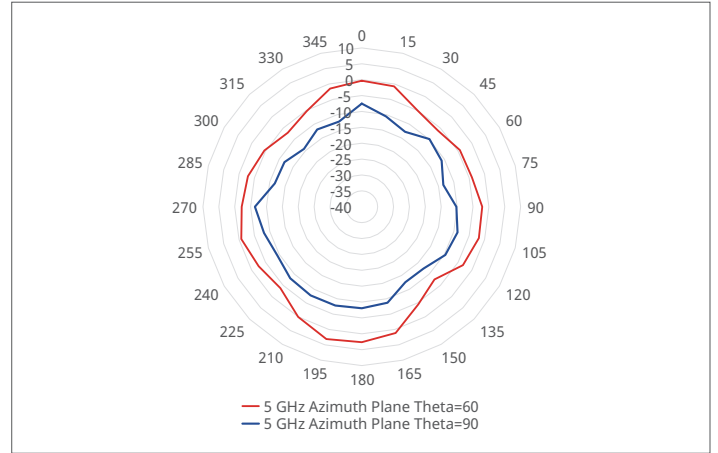
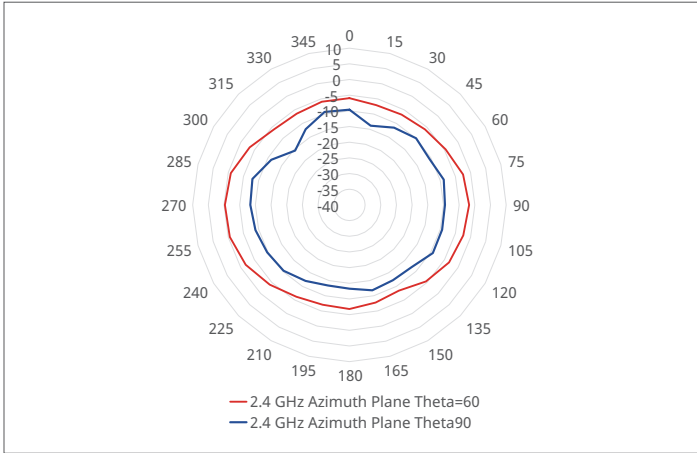

Vertical Planes (Side View, AP Facing Down)

The following figures show the elevation antenna pattern at 2.4 GHz and 5 GHz radios.

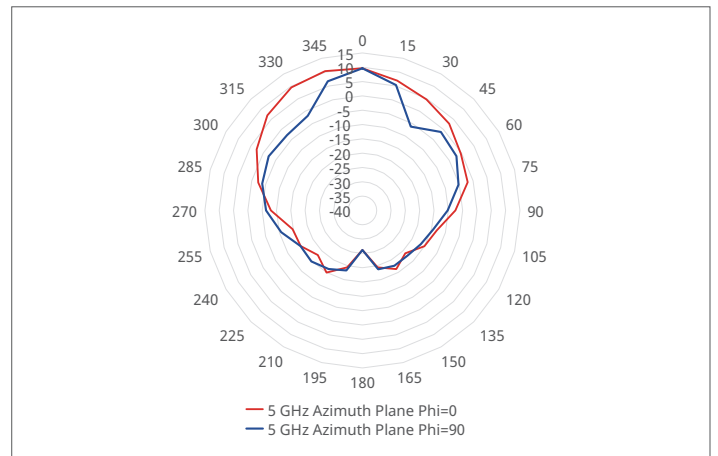
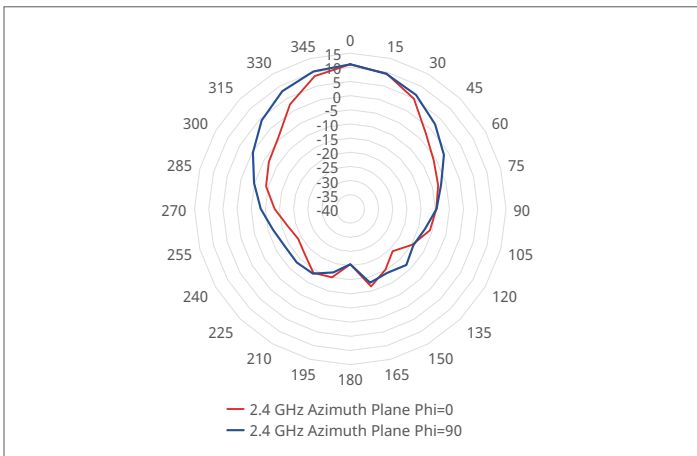

Note: Operating frequency bands are country-specific.

07

Typical Applications

Typical Scenario

The AP is applicable to densely populated areas with simple building structures, no special obstructions, and a large capacity demand. Such areas cover the scenarios of higher education, wireless city, energy, and plaza. The AP can be flexibly deployed based on the environment.

The following figure shows the typical network topology of the RG-AP680(CD).

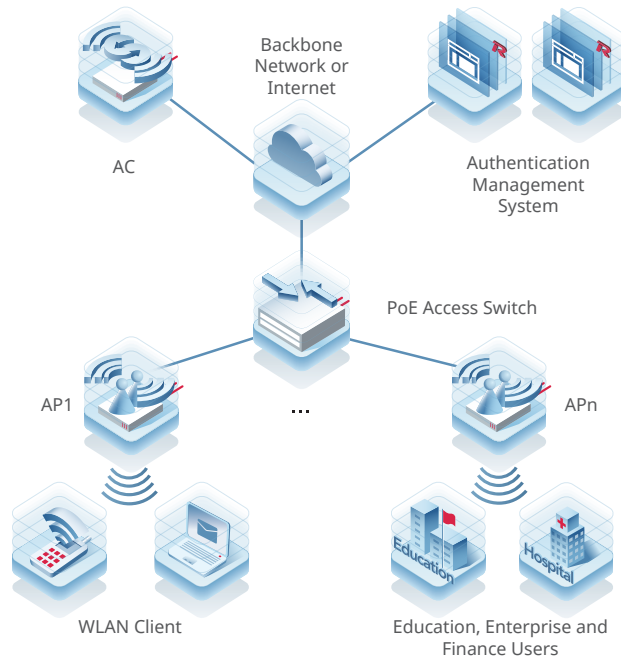

Public Cloud Deployment

With Ruijie public cloud service, the RG-AP680(CD) is fit for SME scenarios, including small offices, boutique hotels, and retail stores. Ruijie Networks provides customers with Ruijie Cloud lifetime free licenses. It significantly streamlines the IT operational efficiency, and simplifies wireless deployment with cost-effective options for SMEs.

The Ruijie Cloud service provides network provisioning, monitoring, optimization, operation, and maintenance. Devices can be easily deployed or swapped in plug-and-play mode. Automatic RF planning meets the needs of increasing user experience.

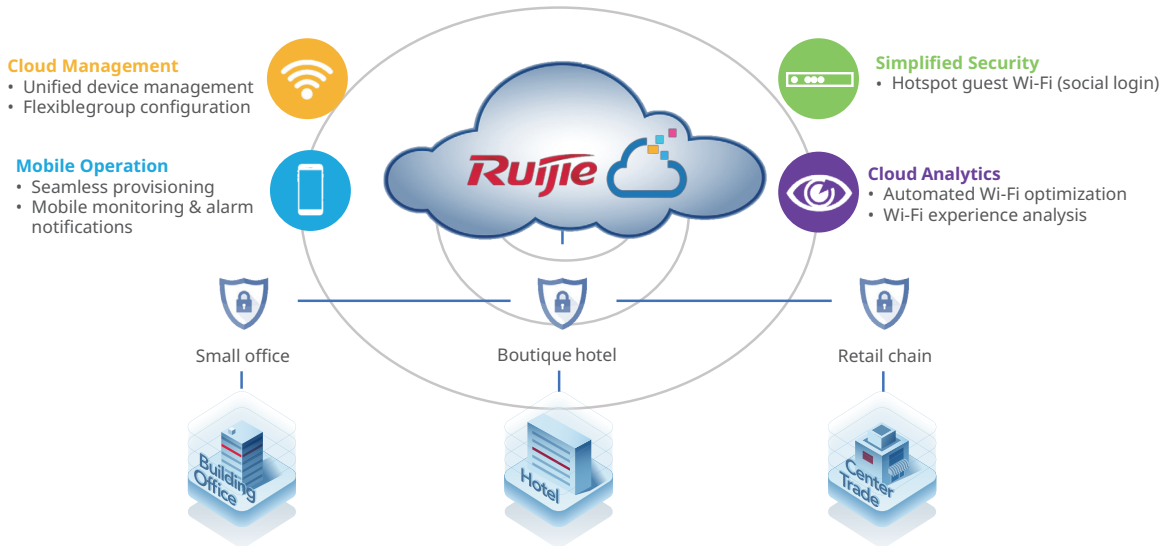

Key Features:

- Unified device management
- Fast provisioning by Cloud and App
- Captive portal
- App-based monitoring and alarm

Hybrid Cloud Deployment

For enterprise office, campus network, and hospitality customers with single or multiple sites, a hybrid mode consisting of Ruijie RG-WS series wireless access controller (on-premises) and cloud-based management (optional) is recommended for high-density AP deployment. Wireless access controllers are installed at the customer's site with fully integrated wireless management and authentication features, supporting large-scale AP management with cluster-based controller architecture. Optionally, the cloud management platform allows for value-added features such as centralized device configuration and monitoring, and reporting.

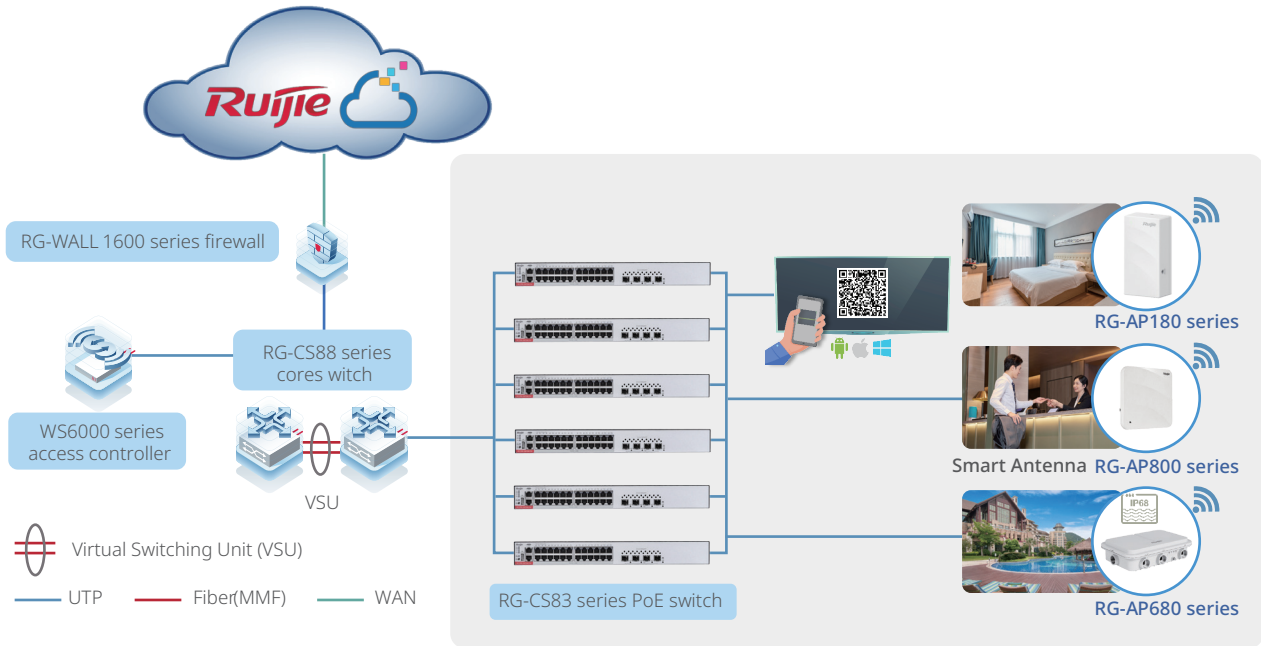

Key Features:

- Centralized device management and reporting by Ruijie Cloud
- Ultra-seamless roaming management
- High performance and security with all user authentication and traffic forwarding handled locally
- Flexible authentication options, including 802.1X and voucher authentication
- Unified management of all series of Ruijie APs

Note: For more applicable scenarios, contact Ruijie pre-sales engineers.

08 Ordering Information

Model	Description
RG-AP680(CD)	Wi-Fi 6 dual-radio outdoor wireless access point Up to four spatial streams Data rate of up to 2.402 Gbps Compliance with IEEE 802.11a/b/g/n/ac and 802.11ax standards Fat/Fit/Cloud mode switchover IEEE 802.3af-compliant power supply and DC power supply

09

Package Contents

Item	Quantity
Main unit	1
Mounting plate assembly	1
Wall/Pole-mount bracket	1
M5 x 10 mm machine screw	4
M6 x 20 mm machine screw	2
M6 x 50 mm expansion anchor	4
Watertight cable gland for the Ethernet cable and power cord	2
Watertight cable gland for the optical cable	1
Cable tie	1
Hose clamp	2
Grounding cable	1
Dust cap	3
Warranty Card	1

10

Warranty

For more information about warranty terms and period, contact your local sales agency:

- Warranty terms: <https://www.ruijie.com/support/servicepolicy>
- Warranty period: <https://www.ruijie.com/support/servicepolicy/Service-Support-Summary>

Note: The warranty terms are subject to the terms of different countries and distributors.

11

More Information

For more information about Ruijie Networks, visit the official Ruijie website or contact your local sales agency:

- Ruijie Networks official website: <https://www.ruijie.com/>
- Online support: <https://www.ruijie.com/support>
- Hotline support: <https://www.ruijie.com/support/hotline>
- Email support: service_rj@ruijie.com
- *WLAN Country or Region Codes and Channel Compliance*: https://www.ruijie.com/support/documents/slide_wlan-country-codes-overview

The Ruijie logo is displayed in a bold, italicized red font. It is centered within a large, light blue, semi-transparent graphic that resembles a stylized 'R' or a rounded square with a diagonal cut. The background features abstract geometric shapes and lines in shades of blue and red.

Copyright ©2000-2023 Ruijie Networks Co., Ltd. All rights reserved.

No part of this document may be reproduced or transmitted in any form or any means without prior written consent of Ruijie Networks Co., Ltd.

Notice

This content is applicable only to regions outside the China mainland. Ruijie Networks Co., Ltd. reserves the right to interpret this content.

The information contained herein is subject to change without notice. Nothing herein should be construed as constituting an additional warranty. Ruijie Networks Co., Ltd. shall not be liable for technical or editorial errors or omissions contained herein.



Ruijie Networks Co., Ltd
Website: <https://www.ruijie.com>