

SKU SUD-HD-8003

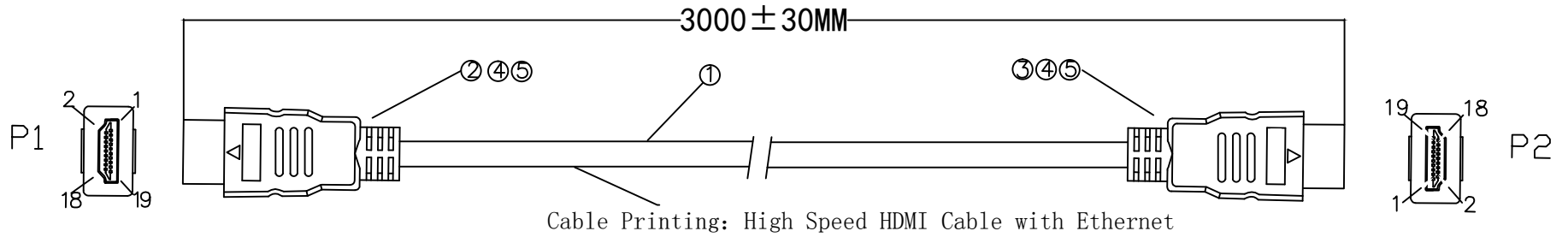

Wiring diagram

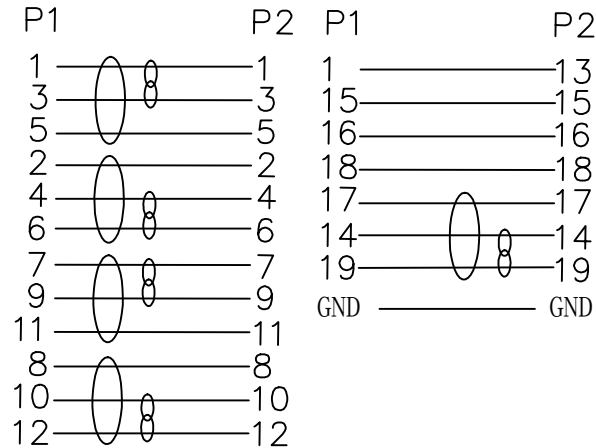
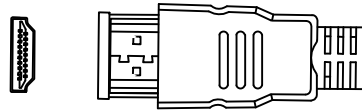

TEST:4K compatible
 CONDUCTOR RESISTANCE:10 OHMS MAX
 INSULATOR RESISTANCE:10M OHMS MIN
 HI-POT:DC 300V 0.10 SEC.

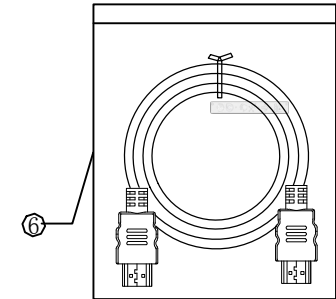

⑥	Package	Blank cable bag with cable loops (502-024)	*PCS	
⑤	Instrument material	45P black material (201-003)	*G	
④	Instrument material	7144PEinner membrane material (201-021)	*G	
③	Plugs	HDTV plugs 20P gold-plated with soldered tips, black core (101-001)	*PCS	
②	Plugs	HDTV plugs 20P gold-plated with soldered tips, black core (101-001)	*PCS	
①	Cable	(1/0.25BC*1P+D1/0.25BC+AL)*5C+1/0.25BC*4C+AL+D1/025BC+96BLMS0D5.5 BLACK (601-015)	*M	
NO.	Name	Specification	Quantity	Remark

